

Speed Dependence and Crack Addiction

by Ares J. Rosakis

Kids, don't try this at home. In a set of high-speed photos (below) shot by Owen and grad student David Anderson, a toy car suffers a head-on collision with a one-inch ball bearing shot from an air gun.

The car's body was one piece of die-cast metal, so the hood only became a moving part once the impact tore it loose. And in a famous Edgerton photo (right), a bullet piercing Plexiglas makes a cornucopia of Mach cones.

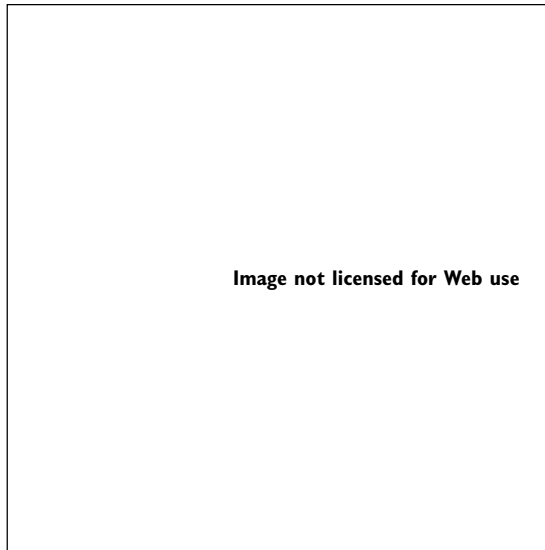

I'm a fracture mechanic, which means that I spend my time breaking things in the laboratory. My wife, Ioanna, who is a psychologist, says this shows there must be something wrong with me. My retort is that at least my specimens, unlike her patients, do not cry when they're subjected to stress. In my labs at the Graduate Aeronautical Laboratories at Caltech (GALCIT) we subject materials to very high rates of stress in a controlled manner by dropping weights on them or shooting air guns at them—we have a variety of whacking machines—and then we photograph them as they break. We're watching how cracks grow over very short time scales, a few millionths of a second, to try to find out how material bonds break and whether there's a speed limit for crack propagation. Can cracks travel supersonically, for example? In this article, I'll share with you nearly a decade's worth of work by my graduate students, postdocs, and collaborators, and I extend a special thanks to David Owen, senior research scientist and director of our experimental facilities for dynamic solid mechanics. Without these talented people nothing would have been done, and their hard work has recently culminated in some exciting discoveries.

I'll try to relate this work to your everyday experience, which, here in Los Angeles, may include bullets. In the 1930s, Harold Edgerton

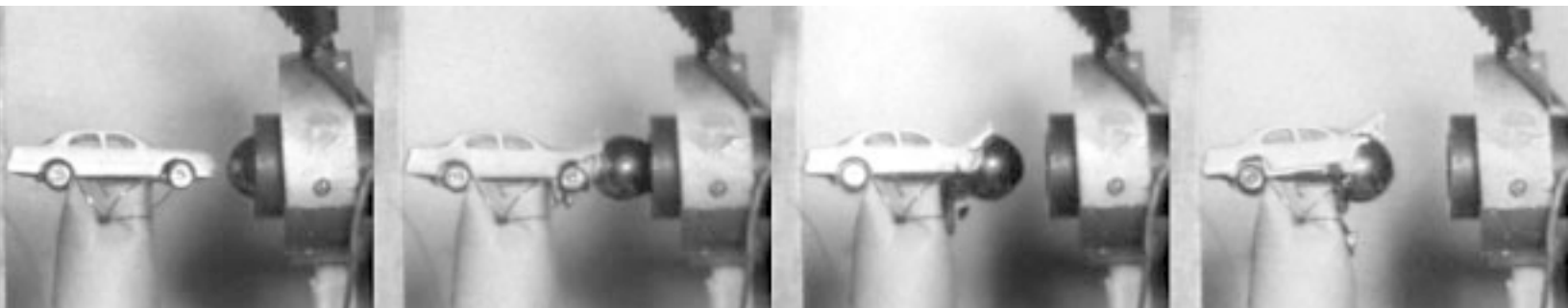

This is heady stuff. We are using experimental methods to explore territory out where the theory doesn't run. We're looking at a whole new set of phenomena.

at MIT took some of the first photographs of a speeding bullet in flight. The photo on the opposite page, shot in 1962, shows a bullet going through a piece of Plexiglas. The bullet's speed is about 800 meters per second, which is about average as bullets go. However, it is much faster than the speed of sound in air, which is about 340 meters per second. As a result, this is a supersonic bullet, so there is a pressure shock wave front, seen as a set of V-shaped lines attached to the tip of the bullet. That shock wave, also called a Mach cone, represents the envelope within which information regarding the disturbance caused by the bullet's passage can travel. A particle of air very close to the bullet but outside the shock wave has no clue at all that the bullet is approaching. You can also see other waves propagating, as well as debris from the Plexiglas, and even some little Mach cones associated with Plexiglas fragments that are moving supersonically as well.

Supersonic aircraft are another part of our everyday experience—some of you may even have traveled in the Concorde. And everyone has their own personal Mach-cone detectors—when you hear a sonic boom, that's a Mach cone sweeping by you.

Now how does this relate to cracks? Well, cracks are disturbances that propagate in a solid instead of air, so in order to see whether a crack is

supersonic, intersonic (I'll get to that in a minute), or subsonic, we have to compare its speed to the speed of sound in that solid. However, solids are more complicated materials than air, and they feature a larger collection of wave speeds than air does. There are basically three major types of waves that solids can sustain. First are the dilatational waves, also called pressure or p waves, equivalent to sound waves in air. Pressure waves vibrate along the direction of their travel, creating alternating regions of compression and expansion, and they propagate at speed c_L . Next come the shear or s waves that propagate at a slower speed, c_S , which is usually less than half of the pressure-wave speed. Shear waves vibrate perpendicularly to their direction of travel. Those of you with an interest in seismology or geology will recognize p and s waves as being associated with earthquakes—seismologists measure the difference in the waves' arrival times in order to calculate how far away the earthquake was, like counting the seconds between the lightning bolt and the thunderclap to see how far away the storm is. Both of these waves are called body waves, because they propagate through the solid's interior. And finally, we have the Rayleigh waves, which are surface waves, which you may also recognize in their earthquake context. Rayleigh waves have a rolling motion, and are equivalent to ripples in water.



Right: Three classes of waves in solids. 1) A dilatational wave stretches and squeezes the solid as it passes through—the segments were originally of equal volume. 2) A shear wave distorts the solid sideways. 3) A Rayleigh wave ripples the solid's surface, in this case while advancing on downtown Los Angeles.

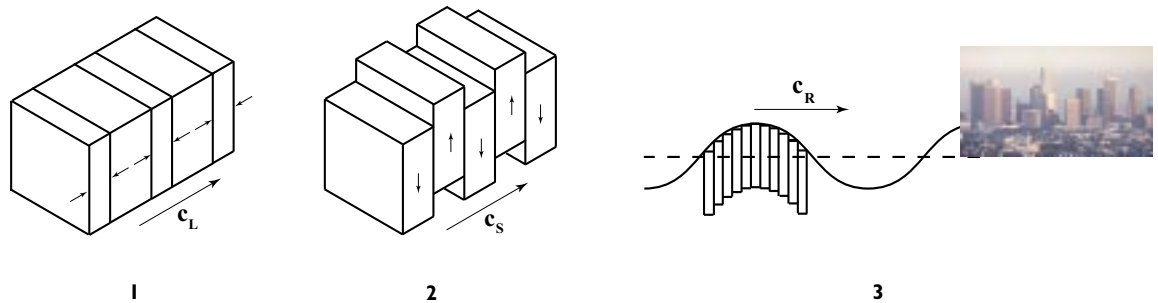

They usually move at about 95 percent of the shear-wave speed, and they are responsible for most of the damage to cities. So when we compare our cracks to these three wave speeds, a supersonic crack is obviously faster than any of them. But if the crack is slower than the dilatational-wave speed and faster than the shear-wave speed, it is called intersonic. For a Mach cone to be visible, the crack must be at least intersonic. (If the crack is supersonic, two Mach cones will exist—one for each wave speed that has been exceeded.) And, of course, if the crack is slower than the body-wave speeds, it is subsonic.

But because solids are much “stiffer” than air, sound propagates much faster, and even subsonic cracks in solids can be moving faster than the speed of sound in air. Above is a series of high-speed photographs that Dave Owen and grad student David Anderson made of a bullet being shot through a light bulb. In the first photo, the bullet has not quite reached the light bulb. In the second photo, shot 30 microseconds (30 millionths of a second) later, the bullet has just touched the glass. Notice that cracks have already propagated from the point of impact, while the bullet has barely moved. This means that the crack tips are moving faster than the bullet. In the third photo, another 30 microseconds have elapsed, and the cracks have run all the way across the face of the bulb. A small calculation shows that these cracks are propagating with speeds on the order of 2,300 meters per second. (Remember, the speed of sound in air is a mere 340 meters per second.)

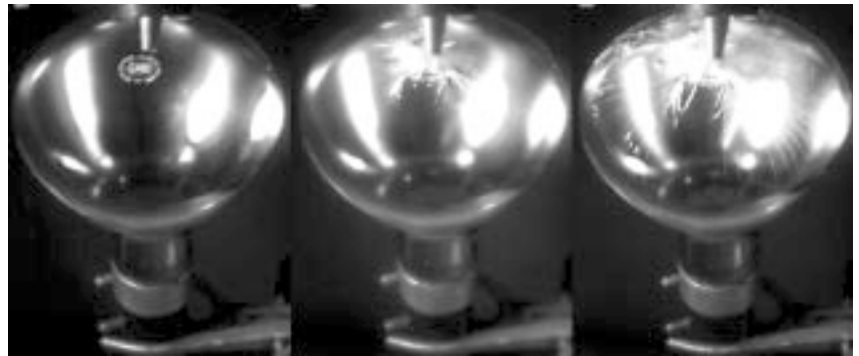

However, these cracks are still subsonic with respect to the glass, because the shear-wave speed of glass is about 3,000 meters per second. You can

also see that the cracks are branching as they go, and the branches are starting to connect with one another to create fragments. (This is also what happens when you break a window. You start with a single crack, which branches. The branches branch, and then they connect into fragments.)

I should mention at this point that there are three different types of cracks. Those in the light bulb and the windowpane are known as Mode I, or “opening,” cracks because they pull apart to create an opening between two halves of the material. Mode II, or “shearing,” cracks are created by sliding one side of the material with respect to the other. These are beloved of geologists—the San Andreas fault, where two crustal plates are sliding against each other along a plane of weakness, ruptures by the creation of Mode II cracks. And Mode III cracks, called “tearing” cracks, are somewhat like the ripping of a piece of paper or cloth. We’ll focus on the first two modes.

Engineers have traditionally dealt with Mode I cracks. That’s the way homogeneous solids—hunks of metal, plastic, or ceramic—usually break. If you have been reading *the* book on dynamic

Well, of course, geophysicists will tell you—naturally shear cracks are important. We've been studying them for years. Earthquake ruptures are just basically big old shear cracks that propagate from here to there on a prescribed path.



Mode I cracks open a material perpendicularly to their direction of travel.



Mode II cracks shear a material along their direction of travel.



Mode III cracks tear a material by shearing it perpendicularly to their direction of travel.

fracture mechanics, by my PhD advisor at Brown University, Ben Freund (who, incidentally, was a JPL distinguished visiting scientist here last year), you will know that in homogeneous elastic solids, the theoretical limiting speed for crack growth in Mode I is the Rayleigh-wave speed of the material. (Remember, the Rayleigh waves are the rolling waves that are heading toward L.A. in the figure.) In practice, the speed of Mode I cracks is even more restricted. Unless there's a weakness for the crack to follow, branching instability sets in at about 40 percent of the Rayleigh-wave speed. In other words, as the crack takes off and starts propagating faster and faster, it prefers to branch in two or more directions rather than continue as a single, faster crack. Then the branches accelerate and branch again, and so on. If there is a weak path—if you scribe a piece of glass with a glass cutter, for example—then you can reach the Rayleigh-wave speed, as Professor of Aeronautics and Applied Mechanics Wolfgang Knauss (BS '58, MS '59, PhD '63) and grad student Peter Washabaugh (MS '84, PhD '90) first demonstrated. But you cannot go faster than that.

Mode II cracks, the shear cracks, have so far been irrelevant to engineers because if you try to shear a solid block of high-strength steel or a brittle plastic, the crack immediately kinks and follows a curved path that creates Mode I conditions locally at the crack tip. The crack has a mind of its own—you load the specimen in a complex way, and the crack will turn so that its tip is opening, rather than shearing, the material. As a result, Mode II crack growth simply couldn't happen in a homogeneous material.

However, engineers are now looking at shear cracks more closely. Take the case of a proposed lightweight design for the Tomahawk cruise missile. The current version is all steel, but you could save weight and increase the range by making the cylindrical body out of a type of fiberglass called S-glass, and then bonding that to the metal nose.

The first few times prototypes were test fired, the launch vibrations caused some cracking at the fiberglass-metal joint, and I suspect that the nose was in danger of falling off. The cracks were trapped in the interface, and they followed that path all the way around the circle. They could not turn, following their natural inclination to accommodate local opening, and as a result these interfacial cracks were shear-dominated. Such cases involving jointed or layered structures have caused engineers to reevaluate composite structures of all sorts in terms of the reliability of their joints under even moderately dynamic loading.

Well, of course, geophysicists will tell you—naturally shear cracks are important. We've been studying them for years. Earthquake ruptures are just basically big old shear cracks that propagate from here to there on a prescribed path. However, nobody knew conclusively how fast they could travel, or how much stress was needed to start them, because growing shear cracks were never observed in the lab. Back in the 1970s, R. Burridge of Schlumberger Cambridge Research Ltd., Freund, Bertram Broberg of the Lund Institute of Technology in Sweden (who was a Sherman Fairchild Distinguished Scholar here at Caltech in 1976–77), Dudley Andrews of the U.S. Geological Survey in Menlo Park, Shamita Das of Oxford, and Keiiti Aki of USC had prophesied that intersonic shear speeds were possible. And there had been hints, first reported by Ralph Archuleta at UC Santa Barbara, that some shallow earthquakes had ruptured faults that fast. But nobody had ever actually seen it happen, and without controlled experimental observations from the laboratory, no theory ever gains a firm footing.

So we set out to create shear cracks in the laboratory. We started by making a composite specimen, like the Tomahawk body-nose structure. We bonded a transparent polymeric panel—we used a plastic called Homalite 100, but it could have been Plexiglas or whatever—to a metal plate,

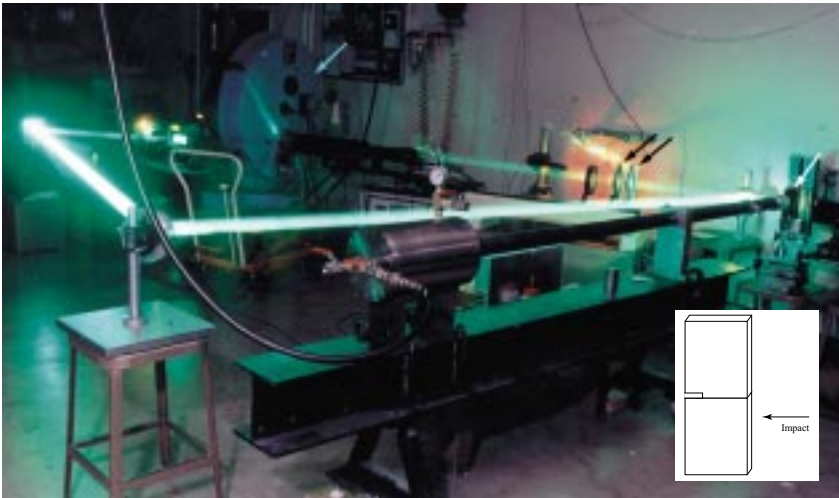

Above: The basic experimental setup for CGS interferometry. A two-inch-diameter laser beam comes from the rear through a system of mirrors to the specimen (white arrow and inset), which butts up against the gas gun—the long pipe and the cylinder connected to the hose in the foreground. The beam is reflected off the highly polished, mirror-smooth specimen through a pair of gratings (black arrows) to create a series of diffraction spots, one of which is trained on the high-speed camera (blue arrow).



Owen holds a typical gas-gun projectile.

The ammunition in the gas gun doesn't even have to be metal. In preparation for JPL's Mars Sample Return project, which is a series of missions that may begin launching by the end of this decade, our lab in collaboration with Mark Adams at JPL is shooting granite slugs at Kevlar-based composite plates. The Sample Return project, as its name implies, proposes to return Mars rocks to Earth in a sealed capsule. In order to save launch weight, the capsule will not have a parachute but will instead plummet into the Utah desert at a terminal velocity of about 100 miles per hour, or roughly 50 meters per second. After all, the contents are just rocks—it's not like they'll be hurt by a hard landing. However, the question has arisen as to whether the impact could hurt the container. In the microsecond when it's hitting the rocky ground at Autobahn speeds, could it be breached and the samples contaminated with boring old earthly bacteria?

edge-to-edge like two cigarette packs stood on end and placed one on top of the other. We sandblasted the metal surface to roughen it, and glued the two pieces together with a mixture of the liquid monomer from which the polymer is made, and the catalyst that starts the polymerization reaction. Thus the bond was made of the same material as the polymer side of the composite so that we weren't adding a layer of adhesive that might alter the system's behavior, and we could control the bond strength by changing how much we roughened the metal or how long we allowed the polymer to cure. At one end of the joint we left an unbonded area, a notch, which concentrated the stresses and initiated the crack, ensuring that it passed through the field of view of a high-speed camera. Then we fired a slug of steel or aluminum at the thin edge of the metal plate opposite to the notch, creating an instantaneous shear stress. In microseconds, a crack had propagated from the notch all the way along the bond to the composite's far end.

This was much faster than any possible movie camera could advance its film, so the film in our camera didn't move. Instead, it was mounted along the inside surface of a drum, and a rotating mirror in the center of the drum swept the images across it. For a light source, we used a laser that pulsed like a strobe in sync with the camera. Of course, the number of frames in our movie was limited by the size of the drum, but we could shoot 80 frames at rates of up to 2 million frames per second. Recently we got a high-resolution digital camera that can shoot 16 frames at up to 100 million frames per second—one of the fastest cameras in the world. The digital-camera system is really made up of 16 individual CCD arrays that all look at the same thing, but are programmed to turn on and off in rapid succession.

In order to see the Mach cones and to measure stresses in the breaking material, we need to record what's going on in the material around



Above: Rosakis and a high-vacuum target chamber being modified for use with the digital camera (the blue-sided box at upper left). Built for plasma-jet studies in 1963 for the late Professor of Aeronautics Lester Lees, and later used by von Kármán Professor of Aeronautics, Emeritus, Anatol Roshko (MS '47, PhD '52), the chamber wouldn't look out of place on a battleship—just the ticket for confining hypervelocity shrapnel.



Above: A peek inside the 2-million-frame-per-second camera, which—believe it or not—uses ordinary 35-millimeter film. The arrow points to the rotating three-sided mirror, which bounces the light off a nest of other mirrors before it finally reaches the film at the periphery—you can see the laser's green dot there. Both cameras were manufactured by the Cordin Company of Salt Lake City, Utah.

And speaking of spacecraft, coherent gradient sensing has found its way up to JPL as well. The Lab, through the System on a Chip project directed by Elizabeth Kolawa, is funding a development project on campus that has led to us patenting CGS for use in measuring the curvatures inherent in microelectronic components. Stresses build up in semiconductor wafers as a result of the thin films of dissimilar materials laid down one upon another. These stresses are exacerbated by the endless cycle of thermal expansion and contraction between, say, day and night on Mars. You sure don't want the top layers of your silicon circuitry to snap apart, so this method may become a vital preflight test to ensure that they won't.

the crack as well as to track the movement of the crack itself. Traditionally, people have studied fractures in transparent materials, because if you shine polarized light through them, you can see interference fringes by looking through a second polarized filter. These fringes are actually maximum shear-stress contours, and the method, called photoelasticity, has been around since the early 1920s. But confining yourself to transparent materials has certain obvious limitations, so about 12 years ago then-postdoc Hareesh Tippur (now a professor at Auburn), grad student Sridhar Krishnaswamy (MS '84, PhD '89, now a professor at Northwestern), and I invented a new method. We called it coherent gradient sensing (CGS), and it works on any smoothly polished, reflective material. The crack distorts the surface ahead of and around itself, and these ripples or slopes in turn distort the reflected light. We pass this light through a pair of gratings to create an interference pattern that we can photograph. Thus, we're actually measuring the slopes on the surface of the specimen in the direction perpendicular to the grating lines, from which we can calculate the stresses.

Back in the early '90s, Tippur and John Lambros (MS '89, PhD '94, now a professor at the University of Illinois) began shooting at our metal-Homalite composite with an impact speed of four meters per second—basically as fast as you can swing your fist—which is nothing. It's far from being ballistic. Yet we found that the crack started at zero speed and rapidly accelerated to about 800 meters per second, very close to the Rayleigh-wave speed of the softer material, i.e., the Homalite. And it did so in only 20 microseconds—a fantastic acceleration on the order of 10 million *gs*. To give you an idea of what that means, the Tomahawk missile achieves only about 10 *gs* when it's fired. The crack's acceleration was impressive, but the top speed was still in line with Mode I theory. However, when the impact speed

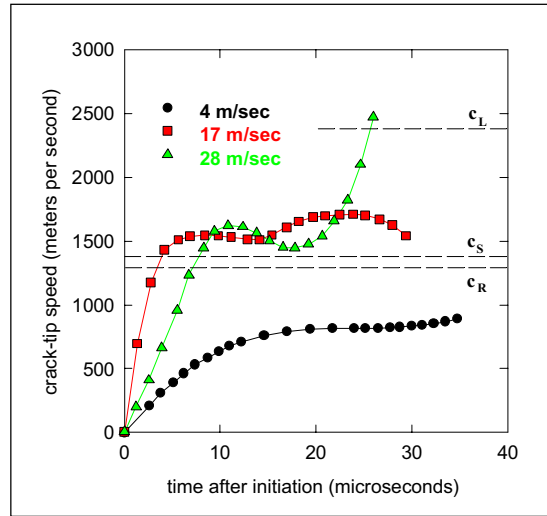

Left: A plot of crack speed as a function of time for a Homalite-steel bimaterial composite at three different impact speeds. The dashed lines are the c_L , c_S , and c_R speeds for Homalite.



In these dynamic photoelasticity pictures of a Homalite-metal composite, the crack is traveling from left to right along the bottom edge of the image. In the top image, the crack is subsonic and the fringes converge on the crack tip. But less than 20 microseconds later, the crack has gone intersonic and three wave fronts, highlighted in red in the inset, are visible. At far right is the model's prediction of how intersonic fringes should look.

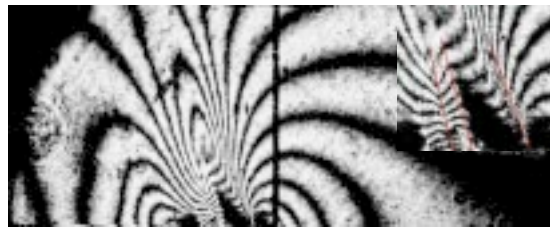

was increased to 17 meters per second, the crack started propagating faster than the Rayleigh-wave speed—and even faster than the shear-wave speed—within 10 microseconds. The crack had become intersonic; it was traveling between c_L and c_S . Ultimately, when the bullet speed was increased to 28 meters per second, the crack even exceeded the dilatational wave speed of the polymer, becoming, for a short time, supersonic with respect to the Homalite.

What you see in the images at left is a concentration of photoelastic fringes that show the location of the crack tip, which travels across the field of view as the pictures progress. But the most stunning part of all this—the most stunning to me, at least—is that the nature of these fringes, even to the untrained eye, changes with time as the crack becomes faster and faster. In the beginning, the fringes all converge on the crack tip, and at the end they have actually formed as many as three distinct sets of inclined lines, which are shear shock waves (jumps in shear stress) equivalent to the shocks made by bullets and airplanes. This shows us, without even making a measurement,

that we have exceeded the shear-wave speed.

But the bullet only made one set of lines, so what's going on here? Going back to your everyday experience, have you ever tried to move a big carpet? You have it all unrolled on the floor, and discover that it's two feet too close

to the wall. But if you just try to pull it, it's very difficult to shift. The easiest way is to hump up a little ripple in it, and then push the ripple across the room. And that's similar, I think, to what's happening here. The Homalite is the carpet, the metal is the floor, and the shear fracture is a ripple

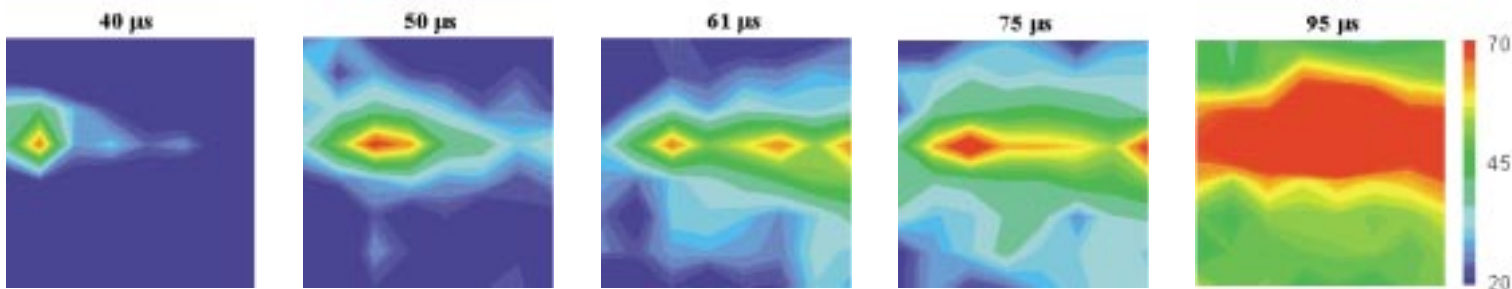

Above: This sequence of thermal maps shows the temperature rise, in centigrade, generated in the wake of a passing intersonic shear crack. As the crack moves by, its faces rub together in frictional contact, causing local hot spots and dissipating heat. (Again, the crack tip is moving from left to right.) These millimeter-square images were made by an infrared camera built at GALCIT by grad student Pradeep Guduru, Rosakis, Professor of Aeronautics G. “Ravi” Ravichandran, and Rosakis’s first grad student, Alan Zehnder (MS ’83, PhD ’87, now a professor at Cornell), who came back on sabbatical for the project. The camera is capable of obtaining 1,000 micro-images at a rate of a million frames per second.

propagating in the interface between the two. The ripple has a distinct tip where it initially separates from the floor. Then the carpet comes down again to touch the floor in frictional contact before the crack is finally pulled apart some distance behind. (As a side note, this friction can generate a lot of heat, as shown in the infrared images above.) I won’t go into details of the proposed mechanism worked out by my grad student Omprakash Samudrala; my colleague Young Huang of the University of Illinois, Urbana-Champaign; and me in 1998. Suffice it to say, it allows us to find the stresses and singularities mathematically, and it predicts three shock waves—at the crack tip, at the point where frictional contact resumes, and at the point of final separation—which in special cases become one or two sets of lines.

This carpet-ripple model is very reminiscent of seismology’s self-healing pulse model of how earthquake ruptures propagate. During an earthquake, a fault does not slip all at once, but moves in a shear pulse that starts at the hypocenter—the earthquake’s underground point of origin; the epicenter is the corresponding point on the earth’s surface—and travels along the fault. As a matter of fact, the self-healing pulse concept was first introduced by Professor of Engineering Seismology Thomas Heaton (PhD ’78) and has been extensively modeled by Harvard’s James Rice (who was a Sherman Fairchild Distinguished Scholar here at Caltech in 1988–89), Northeastern’s George Adams, and USC’s Yehuda Ben Zion. So our results provided a physical, laboratory demonstration that such things as rupture pulses may exist.

When I started showing these results around to the scientific community, some of my colleagues said, “Well, it’s expectable to have intersonic shear-crack growth between two very different materials, because their wave speeds are very different. Stress information travels very fast in the metal, and loads the interface, ‘pulling’ the crack intersonically with respect to the plastic.

This is no big deal.” The big deal, they said, would be to have the same material on both sides of a weak plane (which incidentally is a more realistic representation of a “young” earthquake fault) and still propagate intersonic pulses in shear. But my notion was that it didn’t matter whether the material was the same or different—it was the existence of the weak plane that allowed cracks to propagate in shear that gave us this result.

So in 1998 Samudrala and grad student Demirkan Coker took two pieces of Homalite and glued them weakly together with the monomer. During the first week of experiments, when the impact speed was only 11 meters per second, the crack turned and followed the direction of local Mode I, the direction of local opening. It thought it was in a homogeneous material—it didn’t recognize the fault, and it propagated subsonically. For weeks we gradually increased the impact speed, but the crack still kept turning away from the intended path and I was starting to get worried. I had made a bet with my grad students, you see, and my ego was on the line. But we pressed on, and as we ratcheted up the speed, the crack grew along the interface and we began to see our familiar Mach cones (below). And again we measured crack speeds that approached the

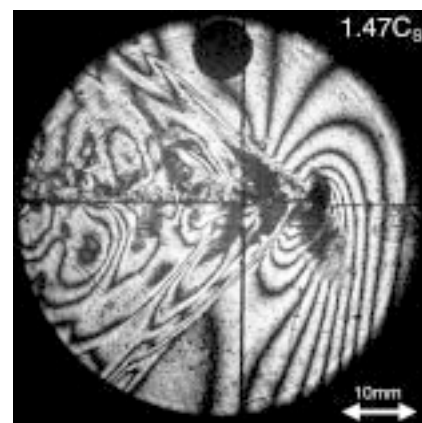

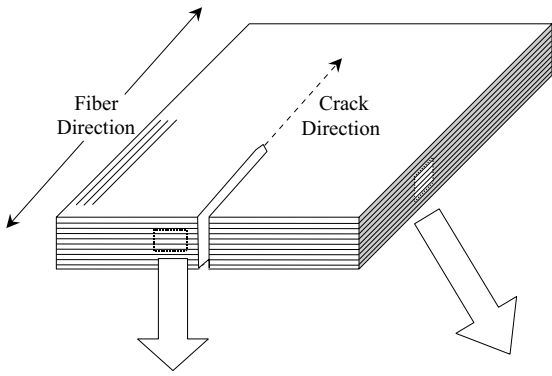

Top: The carbon fibers in this composite material all run parallel to one another. Bottom left: A cross section taken at right angles to the fibers; right: one taken along their length. Both images are 350 microns (millionths of a meter) vertically.



dilatational-wave speed of Homalite. The work was published in *Science* in May 1999.

Now let's look at a different kind of composite material that's widely used in the real world. Above is a pair of photomicrographs of a commercially available carbon-fiber laminate. This stuff is made of small fibers all running in one direction through an epoxy binder. Usually it's built up in layers, like plywood, with the fibers in each layer running at an angle to the fibers in the previous layer. This makes the material very strong, and it's used in everything from jet-engine intake-fan blades to tennis rackets. We knew that the wave speeds along the fibers are much higher than the wave speeds across the fibers. The *p*-wave speed along the fibers is seven and a half kilometers per second. That's fast. So when we drove shear cracks along the fibers, they also accelerated very quickly to this speed—imagine sprinting from Caltech to the Rose Bowl and back again in a second. Our original camera had a very hard time following them, even at 2 million frames per second, which is why we bought the digital camera. This composite is opaque, so we had to use the CGS technique, but the high-speed images still revealed our familiar Mach cones and frictional contact structure. The work will appear in the *Philosophical Magazine, Part A* in August.

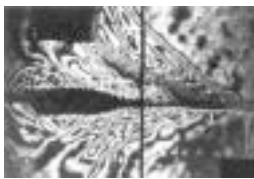

The bullet-like crack in this CGS image is moving at the fantastic speed of 7.5 kilometers per second.

Returning to the question I asked at the beginning—is there a speed limit to crack propagation? All I can give at this point is a partial answer. The Rayleigh-wave speed is not the limit to crack growth. We have reached the dilatational-wave speed, and I believe we've exceeded it, but that wasn't unambiguously beyond experimental error. It's hard to theoretically justify going faster than the dilatational-wave speed, except under very specialized conditions.

This is heady stuff. We are using experimental methods to explore territory out where the theory doesn't run. We're looking at a whole new set of phenomena. And on the practical side, almost everything in the built environment is made of materials bonded to other materials. I'm not just talking about carbon-fiber composites and layered microelectronic structures, but such mundane things as the joints between your chimney bricks, for example. We can get very fast Mode II cracks in materials that were only thought to be able to sustain the much slower Mode I cracks, and we can get very fast Mode II crack growth from very low-speed loadings. So it's possible to have near-instantaneous catastrophic failures in situations where they would not previously have been expected. We can use this knowledge to try to design bonds that resist cracking, or that crack in very predictable ways for specific purposes—layered body armor that disintegrates in a controlled way while protecting the wearer, for example, analogously to the way crumple zones in cars channel the force of an impact away from the occupants. But the biggest immediate advances may be in seismology, where one of the basic tools of the trade is “inverting” measurements from a network of seismometers to determine the source mechanism of an earthquake. The current techniques assume the rupture is subsonic, but the realization that some ruptures occasionally propagate intersonically means we can make more accurate models, thus improving our understanding of earthquakes and their consequences. □

PICTURE CREDITS:
32, 34, 35 — Bob Paz;
32 — Dave Owen, Dave Anderson; 34, 35 — Doug Smith; 36 — Omprakash Samudrala;
37, 38 — Demir Coker;
37 — Coker/Samudrala

Professor of Aeronautics and Applied Mechanics Ares Rosakis obtained his BSc from Oxford in engineering science and his ScM and PhD in solid mechanics from Brown, where he first got hooked on cracks. Upon graduation in 1982, he came to Caltech as an assistant professor, becoming a full professor in '93. A Fellow of the American Society of Mechanical Engineers, he has also been named a Presidential Young Investigator by the National Science Foundation, has received the B. L. Lazan and Heyenyii awards from the Society of Experimental Mechanics, the Rudolph Kingslake medal and prize from the Society of Photooptical Instrumentation Engineers, and an Excellence in Teaching Award from Caltech's Graduate Student Council. This article is adapted from a Seminar Day talk.